

# Canon EF LENS

TS-E24mm f/3.5L

TS-E45mm f/2.8

TS-E90mm f/2.8



ENG

Instructions

## Thank you for purchasing a Canon product.

Canon's TS-E lenses are tilt-shift lenses designed for EOS cameras. The tilt-shift mechanism enables photographers to control the depth of field and the area photographed and to correct image distortion, making it possible to take sophisticated pictures that cannot be shot using a conventional lens.

- To ensure that you make the most of the TS-E lens functionality, it is recommended that you use it with an EOS camera with 100% viewfinder visibility (EOS-1, EOS-1D or EOS-1Ds series) and use the laser matte with grid focusing screen Ec-D and a tripod.
- On EOS cameras with a built-in flash, some partial restrictions may apply to the shift and rotation functions.
- On EOS cameras equipped with a grip for vertical shooting, some partial restrictions may apply to the shift and rotation functions.

### Features

1. The lens can be tilted up to  $\pm 8^\circ$  and shifted up to  $\pm 11$ mm.
2. The tilt and shift functions can be used singly or in combination.
3. The lens can be rotated to change the tilt or shift direction.

#### Conventions used in this instruction



Warning to prevent lens or camera malfunction or damage.



Supplementary notes on using the lens and taking pictures.



## Safety Precautions



### Safety Precautions

- **Do not look at the sun or a bright light source through the lens or camera.** Doing so could result in loss of vision. Looking at the sun directly through the lens is especially hazardous.
- **Whether it is attached to the camera or not, do not leave the lens under the sun without the lens cap attached.** This is to prevent the lens from concentrating the sun's rays, which could cause a fire.

### Handling Cautions

- **If the lens is taken from a cold environment into a warm one, condensation may develop on the lens surface and internal parts.** To prevent condensation in this case, first put the lens into an airtight plastic bag before taking it from a cold to warm environment. Then take out the lens after it has warmed gradually. Do the same when taking the lens from a warm environment into a cold one.
- Do not leave the lens in excessive heat such as in a car in direct sunlight. **High temperatures can cause the lens to malfunction.**

This device complies with Part 15 of the FCC Rules. Operation is subject to the following two conditions: (1) This device may not cause harmful interference, and (2) this device must accept any interference received, including interference that may cause undesired operation.

Do not make any changes or modifications to the equipment unless otherwise specified in the instructions. If such changes or modifications should be made, you could be required to stop operation of the equipment.

This equipment has been tested and found to comply with the limits for a class B digital device, pursuant to part 15 of the FCC Rules. These limits are designed to provide reasonable protection against harmful interference in a residential installation. This equipment generates, uses and can radiate radio frequency energy and, if not installed and used in accordance with the instructions, may cause harmful interference to radio communications.

However, there is no guarantee that interference will not occur in a particular installation. If this equipment does cause harmful interference to radio or television reception, which can be determined by turning the equipment off and on, the user is encouraged to try to correct the interference by one or more of the following measures:

- Reorient or relocate the receiving antenna.
- Increase the separation between the equipment and receiver.
- Consult the dealer or an experienced radio/TV technician for help.

---

This Class B digital apparatus complies with Canadian ICES-003.

# Nomenclature

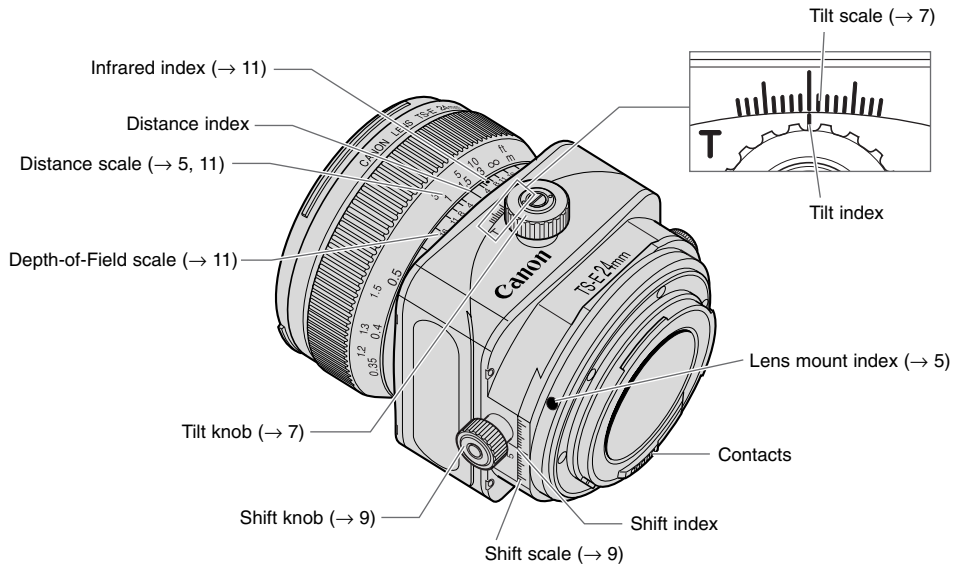

For detailed information, reference page numbers are provided in parentheses (→ \*\*).

## Nomenclature

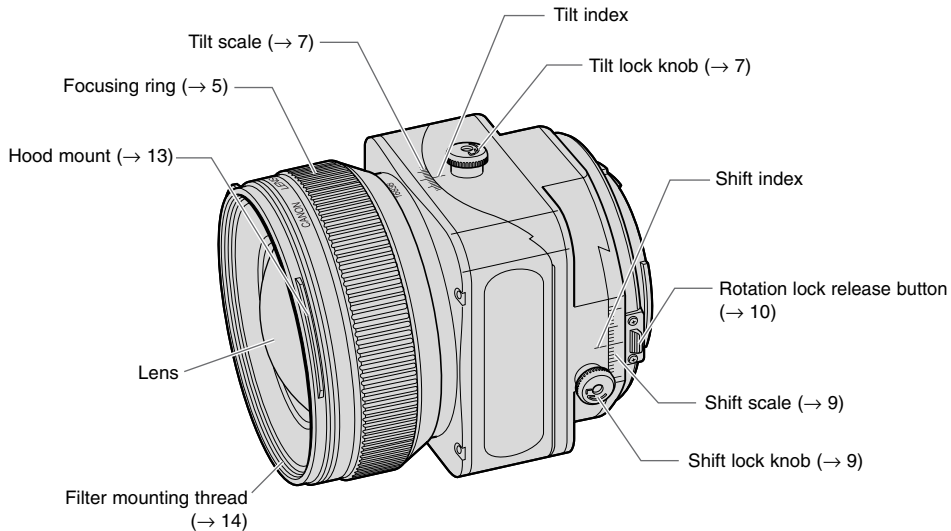

For detailed information, reference page numbers are provided in parentheses (→ \*\*).

## 1. Mounting and Detaching the Lens

See your camera's instructions for details on mounting and detaching the lens.

- When mounting or detaching the lens, always ensure that the tilt and shift scales are set to the "0" position.
- After detaching the lens, place the lens with the rear end up to prevent the lens surface and contacts from getting scratched.
- If the contacts get soiled, scratched, or have fingerprints on them, corrosion or faulty connections can result. The camera and lens may not operate properly.
- If the contacts get soiled or have fingerprints on them, clean them with a soft cloth.
- If you remove the lens, cover it with the dust cap. To attach it properly, align the lens mount index and the  index of the dust cap, and turn clockwise. To remove it, reverse the order.

## 2. Focusing

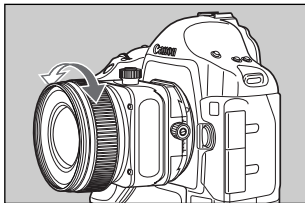

Focus a TS-E lens by turning the focusing ring.  
(Shots cannot be taken using the auto focus.)

- After using tilt or shift, readjust the focus.
- The distance scale is only valid when the tilt scale is set to the "0" position.

### 3. Tilt Function

Tilting inclines the lens relative to the image plane. When the tilt scale is set to the “0” position, the focusing and imaging planes are parallel. However, tilting puts the focusing plane at an angle to the imaging plane.

● Example 1



● Example 2



To shoot so that all of an extensive subject is in focus, you must normally use a small aperture to obtain a large depth of field. But tilting allows you to keep all of the subject in focus even when there is insufficient depth of field (Example 1). Or, by tilting in the opposite direction, you can focus on a specific part of the subject (Example 2).

## Using Tilt

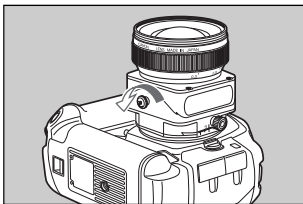

**1** Loosen the tilt lock knob by turning it in the direction of the arrow.

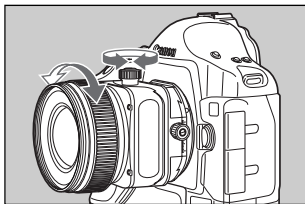

**2** Turn the tilt knob to adjust the amount of tilt. Focus the shot by turning the focusing ring.

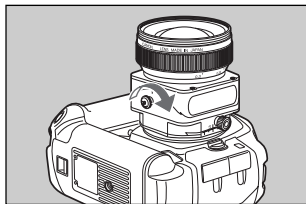

**3** Turn the tilt lock knob in the direction of the arrow to lock the amount of tilt for the shot.

- When you tilt the lens, sharp portions of the tilt mechanism are exposed and care should be taken to avoid touching these portions.
- If you use the tilt and shift functions on the TS-E24mm f/3.5L at the same time, only use them within the area of the light-gray tilt scale settings. Tilting the lens to other settings may cause vignetting. However, if the tilt function is used alone, none of the tilt scale settings cause vignetting.



## 4. Shift Function

Shifting moves the optical axis of the lens in parallel off the center of the imaging plane. Shift can be used to good effect in the situations shown below.



- If you photograph a subject such as a building with a normal lens, the top of the building tapers away. But by placing the camera parallel to the building and shifting the lens, you can correct this tapering effect.



- When you are shooting a reflective subject, you can move the camera to a position where the camera does not appear in the shot and then use shift to take the picture. This lets you keep the camera out of the shot without having to change the shot composition.

## Using Shift

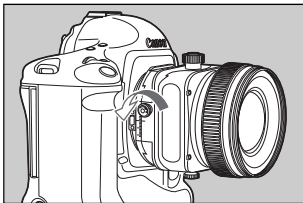

- 1 Loosen the shift lock knob by turning it in the direction of the arrow.

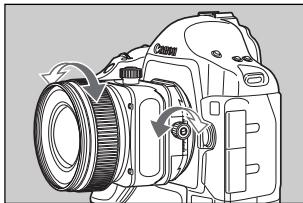

- 2 Turn the shift knob to adjust the amount of shift. Focus the shot by turning the focusing ring.

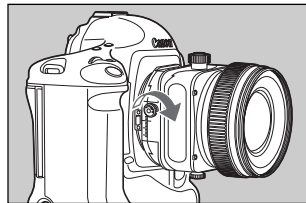

- 3 Turn the shift lock knob in the direction of the arrow to lock the amount of shift for the shot.

- When you shift the lens, sharp portions of the shift mechanism are exposed and care should be taken to avoid touching these portions.
- If you use the tilt and shift functions on the TS-E24mm f/3.5L at the same time, only use them within the area of the light-gray shift scale settings. Shifting the lens to other settings may cause vignetting.

- With large amounts of shift, the amounts of peripheral light at the top and bottom or left and right sides of the screen may differ, so shooting with a small aperture is recommended.

## 5. Rotation

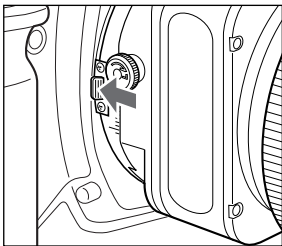

The rotation function enables you to change the direction of tilt or shift by rotating the tilt-shift mechanism.

With the lens mounted on the camera, push the rotation lock release button towards the mount and then turn the tilt-shift mechanism.

- The mechanism can be rotated through  $\pm 90^\circ$ . The lens clicks every  $30^\circ$  and locks in place in the  $90^\circ$  position.
- When rotating the lens, set the tilt and shift scales to the “0” position.
- Note that rotating the tilt-shift mechanism quickly while pressing on the rotation lock release button may cause the shift lock knob to strike your fingers.

## 6. Depth-of-Field Scale (TS-E24mm f/3.5L)

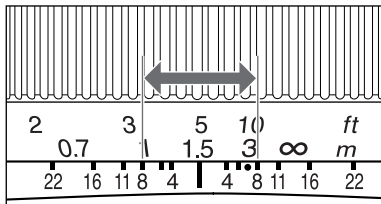

The depth of field is the distance in front of and behind the plane of focus on the subject that appears sharp. The depth of field is indicated by the area between the depth-of-field scale lines below the distance scale. The numbers on the scale are F values, and for example, if the shooting distance is 1.5 m and the aperture is f/8, the area in focus will extend from about 1 m to 3 m.

- The depth-of-field scale is only valid when the tilt scale is set to the “0” position.
- The depth-of-field scale is an approximate indicator.

## 7. Infrared Index (TS-E24mm f/3.5L)

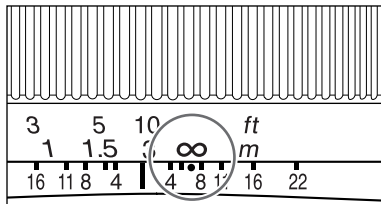

The infrared index corrects the focus setting when using monochrome infrared film. Focus on the subject in MF, then adjust the distance setting by moving the focusing ring to the corresponding infrared index mark.

ⓘ Some EOS cameras cannot use infrared film. See the instructions for your EOS camera.

- The infrared index position is based on a wavelength of 800 nm.
- Be sure to observe the manufacturer's instructions when using infrared film.
- Use a red filter also when you take the picture.

## 8. TS-E Tripod Adapter (Sold Separately)

With some camera models, the tilt, shift and rotation functions can no longer be used when the camera is mounted directly on a tripod. When this happens, fit the optional TS-E tripod adapter into the tripod mount socket on the camera before mounting the camera on the tripod.

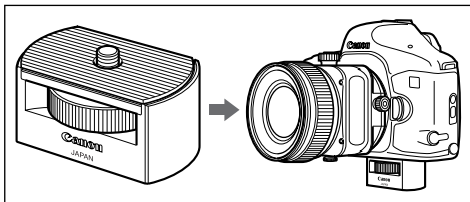

## 9. Exposure

Shots can be taken using AE (automatic exposure) as long as the tilt and shift scales are set to the “0” position.

The use of AE is not recommended when the lens is tilted or shifted as exposure errors may result. It is recommended that you use the exposure values when the tilt and shift scales are set to the “0” position as a guide and then take the shot with as many exposure settings as possible.

## 10. Hoods

The EW-75B II, EW-79B II and ES-65 III lens hoods can keep unwanted light out of the lens, and also protects the lens from rain, snow, and dust.

Attach the hood using the following procedure.

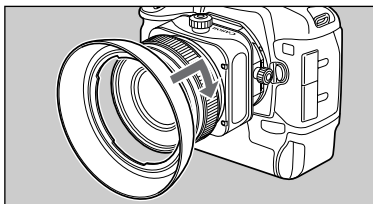

### TS-E24mm f/3.5L

Turn the hood in the direction of the arrow to attach it securely.

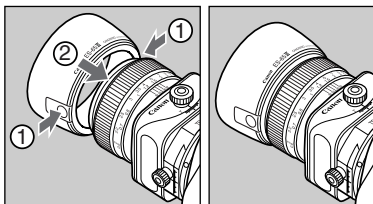

### TS-E45mm f/2.8 • TS-E90mm f/2.8

- 1) Pressing the buttons on the base of the hood inwards, push the hood onto the hood mount on the lens.
- 2) Release the buttons so that the catches on the hood fit into the grooves on the mount.

## Hoods

-  ● Part of the picture may be blocked if the hood is not attached properly.
- When attaching or detaching the hood, grasp the base of the hood to turn it. To prevent deformation, do not grasp the rim of the hood to turn it.

 The hood can be reverse-mounted on the lens for storage.

## 11. Filters (Sold Separately)

You can attach filters to the filter mounting thread on the front of the lens.

-  ● Only one filter may be attached.
- Use a polarizing Canon filter.
- To adjust the polarizing filter, first remove the lens hood.

## 12. Extension Tubes

(Sold Separately)

You can attach extension tube EF12 II or EF25 II for magnified shots. The shooting distance and magnification are shown below.

### TS-E24mm f/3.5L

|         | Focusing Distance Range (mm) |               | Magnification (×) |               |
|---------|------------------------------|---------------|-------------------|---------------|
|         | Close distance               | Long distance | Close distance    | Long distance |
| EF12 II | 171                          | 179           | 0.62              | 0.49          |
| EF25 II | 166                          | 167           | 1.21              | 1.10          |

### TS-E45mm f/2.8

|         | Focusing Distance Range (mm) |               | Magnification (×) |               |
|---------|------------------------------|---------------|-------------------|---------------|
|         | Close distance               | Long distance | Close distance    | Long distance |
| EF12 II | 239                          | 299           | 0.44              | 0.27          |
| EF25 II | Cannot be used               |               |                   |               |

### TS-E90mm f/2.8

|         | Focusing Distance Range (mm) |               | Magnification (×) |               |
|---------|------------------------------|---------------|-------------------|---------------|
|         | Close distance               | Long distance | Close distance    | Long distance |
| EF12 II | 415                          | 817           | 0.43              | 0.14          |
| EF25 II | 373                          | 486           | 0.60              | 0.31          |

## 13. Close-up Lenses

(Sold Separately)

Attaching a 250D or 500D close-up lens enables close-up photography. Compatibility with close-up lenses is as follows.

### TS-E24mm f/3.5L

- 250D: Cannot be used
- 500D (72mm): 0.19 to 0.05×

### TS-E45mm f/2.8

- 250D: Cannot be used
- 500D (72mm): 0.25 to 0.09×

### TS-E90mm f/2.8

- 250D (58mm): 0.69 to 0.36×
- 500D (58mm): 0.49 to 0.18×



# Specifications

|                                   |            | <b>TS-E24mm f/3.5L</b>  | <b>TS-E45mm f/2.8</b>                  | <b>TS-E90mm f/2.8</b>         |
|-----------------------------------|------------|---|--|-------------------------------|
| <b>Focal Length/Aperture</b>      |            | 24mm f/3.5  | 45mm f/2.8                             | 90mm f/2.8                    |
| <b>Lens Construction</b>          |            | 9 groups, 11 elements   | 9 groups, 10 elements                  | 5 groups, 6 elements          |
| <b>Minimum Aperture</b>           |            | f/22  | f/22                                   | f/32                          |
| <b>Angle of View<br/>(Normal)</b> | Diagonal   | 84°   | 51°                                    | 27°                           |
|                                   | Vertical   | 53°   | 30°                                    | 15° 11'                       |
|                                   | Horizontal | 74°   | 44°                                    | 22° 37'                       |
| <b>Min. Focusing Distance</b>     |            | 0.3m (1.0ft.)   | 0.4m (1.3ft.)                          | 0.5m (1.6ft.)                 |
| <b>Max. Magnification</b>         |            | 0.14×   | 0.16×                                  | 0.29×                         |
| <b>Field of View</b>              |            | 173 × 263mm<br>(6.8 × 10.4inch)                                 | 150 × 226mm<br>(5.9 × 8.9inch)         | 82 × 123mm<br>(3.2 × 4.8inch) |
| <b>Tilt amount</b>                |            | ±8°   |  |                               |
| <b>Shift amount</b>               |            | ±11mm   |  |                               |
| <b>Tilt scale display</b>         |            | Each degree from 0 to<br>±6° (light gray),<br>±7° and ±8° (red) | Each degree from 0 to ±8° (light gray) |                               |
| <b>Shift scale display</b>        |            | Each mm from 0 to<br>±7mm (light gray),<br>±8 to ±11mm (red)    | Each mm from 0 to ±11mm (light gray)   |                               |
| <b>Rotation mechanism</b>         |            | Locks at -90°, 0° and +90°, clicks every 30°                    |  |                               |

## Specifications

|                                 | <b>TS-E24mm f/3.5L</b>      | <b>TS-E45mm f/2.8</b>       | <b>TS-E90mm f/2.8</b>       |
|---------------------------------|-----------------------------|-----------------------------|-----------------------------|
| <b>Filter Diameter</b>          | 72mm                        |                             | 58mm                        |
| <b>Max. Diameter and Length</b> | 78 × 86.7mm (3.1 × 3.4inch) | 81 × 90.1mm (3.2 × 3.5inch) | 73.6 × 88mm (2.9 × 3.5inch) |
| <b>Weight</b>                   | 570g (18.4oz)               | 645g (20.8oz)               | 565g (18.2oz)               |
| <b>Hood</b>                     | EW-75B II                   | EW-79B II                   | ES-65 III                   |
| <b>Lens Cap</b>                 | E-72                        |                             | E-58                        |
| <b>Case</b>                     | LP1216                      |                             | LP1016                      |

- The lens length is measured from the mount surface to the front end of the lens. Add 21.5 mm when including the lens cap and dust cap.
- The size and weight listed are for the lens only, except as indicated.
- The EF1.4× II/EF2× II extenders cannot be used with the lenses listed above.
- Aperture settings are specified on the camera.
- All data listed is measured according to Canon standards.
- Product specifications and appearance are subject to change without notice.

# Canon